



PLASMA CUTTER

RBC4500L/RBC6000L/RBC6000DL









User Manual

<https://www.rebootec.com>



Dear Valued Customer,

Thank you for going with REBOOT. We're all about making plasma cutters superior for you. REBOOT was built by high quality components, every single unit machine was passed multiple industry leading laboratory tests to provide a great welding experience and performance. Minor marks from testing may be present on the equipment, which is normal. Plasma cutter are high-power devices. If your circuit breaker has insufficient capacity, it may trip frequently. Please check whether other high-power appliances are operating on the same circuit, or reduce the output power of the equipment accordingly. For optimal performance, the use of genuine original accessories is highly recommended. For your safety, please read and understand this manual carefully before using this product. Your satisfaction is our priority! For any question or concerns, please do not hesitate to contact REBOOT for SUPPORT :

	Europe and UK	service-eu@mirthtek.com	
	North America	service@mirthtek.com	
	South America and Others	nancy@weldvip-service.com	
	+86 18938887689		+86 18938887689
	Reboot Welding Solutions		+86 18923725124
	weldflowhub		https://www.rebootec.com

User Manual

Manuel utilisateur

Руководство пользователя

取扱説明書

Manuale utente

Manual de usuario

Benutzerhandbuch



Content

1. SAFETY	2
1.1 General Safety	2
1.2 Electrical Safety	2
1.3 Fire Safety	3
1.4 Fumes and Gases Safety	4
1.5 Arc Rays and Noice Safety	4
1.6 Gas Shielded Cutting – Cylinder Safety	5
1.7 Additional Safety Information	5
1.8 Symbol Explanation	5
2. PRODUCT OVERVIEW	6
2.1 Functions and characteristics:	6
2.2 TECHNICAL PARAMETERS	7
2.3 Package	8
3. Panel Instruction	9
4. INSTALLATION AND CONNECTION	10
1.Connection of air compressor	10
2.Installation of the cutting torch	11
3.Connection of earth cable	12
4.Connection of input power	12
5.Operation	13
5.1 Pilot Cutting	14
5.2 Optimized Operation Guidelines	15
5.3 Parts in place	15
5.4 Pilot Arc Operation & Guidelines	16
5.5 Notes for cutting operation	17
6.Cutting Guide	19
7. MAINTENANCE	20
8. TROUBLESHOOTING	22
9. Warranty Registration	24

1.SAFETY

WARNING



READ ALL SAFETY WARNINGS BEFORE WORKING!

Failure to follow the warnings and instructions may result in electric shock, fire and/or serious injury. Save all warnings and instructions for future reference!

If you encounter any issues during installation or operation, refer to the relevant sections in this manual for inspection. If you're still unsure or unable to resolve the problem, please contact REBOOT professional support.

1.1 General Safety

- Do NOT use the plasma cutter if the switch does not turn it on and off.
- Disconnect the plug from the power source before making any adjustments, changing accessories, or storing the plasma cutter.
- Ensure the switch is off before connecting to power or moving the plasma cutter to prevent accidental starting.
- Always maintain and use safety guards, covers, and devices properly.
- Keep hands, hair, clothing, and tools away from moving parts like V-belts, gears, and fans.
- Follow these instructions and consider working conditions when using the plasma cutter and accessories.
- This manual may not cover every possible situation. It's important for the operator to use common sense and caution while using this product.

1.2 Electrical Safety

WARNING



BEWARE OF ELECTRIC SHOCK!



- DO NOT cut in a damp area or come in contact with a moist or wet surface.
- DO NOT modify any wiring, ground connections, switches, or fuses in this cutting equipment.

- DO NOT come into physical contact with any part of the cutting current circuit, including the workpiece, ground clamp, electrode or cutting wire, and metal parts on the electrode holder or MIG gun.
- DO NOT connect the ground clamp to electrical conduit, and DO NOT cut on electrical conduit.
- NEVER leave the plasma cutter unattended while energized. Turn off the power if you have to leave.
- DO NOT attempt to plug the plasma cutter into the power source if the ground prong on INPUT POWER CABLE plug is bent over, broken off, or missing.
- DO NOT alter INPUT POWER CABLE or plug in any way.
- People with pacemakers should consult their physicians before use. Magnetic field can make cardiac pacemaker a bit wonky.

WARNING



REPLACING COMPONENTS CAN BE DANGEROUS!

- Only experts should replace machine parts. Avoid dropping foreign objects into the machine during component replacement. Ensure correct wire connections after replacing PCBs to prevent property damage.

1.3 Fire Safety

WARNING



BEWARE OF FIRE HAZARD!



- Place the machine on non-combustible surfaces to prevent fires.
- Ensure no flammable materials are near the working area to reduce fire risk.
- Avoid installing the machine near water sources to prevent water damage.
- Always weld/cut materials in a dry environment with humidity below 90% and maintain a working temperature between -10°C and 40°C.
- When welding/cutting outdoors, ensure shelter from sunlight and rain, keeping the machine dry at all times.
- Do not operate the machine in dusty or chemically corrosive environments.

- Remove or secure all combustible materials within a 35 feet (10 meters) radius of the work area. Use fire-resistant material to cover or seal open doorways, windows, cracks, and other openings.
- Improper use can lead to fire or explosion. Avoid flammable materials near the working area, keep a fire extinguisher nearby with trained personnel, refrain from cutting closed containers, and do not use the machine for pipe thawing.

1.4 Fumes and Gases Safety

WARNING



SMOKE CAN BE HARMFUL TO YOUR HEALTH!



- Keep your head away from the smoke while cutting to avoid breathing in harmful gases.
- Ensure the working area is well-ventilated with exhaust or ventilation equipment during cutting.
- Only work in a confined area if it's well-ventilated, or wear an air-supplied respirator.

1.5 Arc Rays and Noise Safety

WARNING



EXCESSIVE NOISE DOES GREAT HARM TO HEARING!



ARC RADIATION MAY HURT YOUR EYES AND BURN YOUR SKIN !

- Arc radiation can harm eyes and skin; excessive noise can damage hearing.
- Use certified cutting eye protection with at least a number 10 shade lens rating.
- Wear leather leggings and fire-resistant shoes or boots; avoid clothing that can catch sparks or molten metal. Do not touch hot workpiece with bare hands.
- Keep clothing free of flammable substances and wear dry, insulating gloves and protective clothing.
- Wear an approved head covering and use appropriate cutting attire.
- When cutting overhead or in confined spaces, use flame-resistant ear plugs or ear muffs.
- Wear ear covers or other hearing protectors when cutting.

1.6 Gas Shielded Cutting – Cylinder Safety

WARNING



CYLINDERS CAN EXPLODE WHEN DAMAGED!



- Never cut on a pressurized or closed cylinder.
 - Avoid letting the electrode holder, electrode, cutting torch, or cutting wire touch the cylinder.
 - Keep cylinders away from all electrical circuits, including cutting circuits.
 - Always keep the protective cap on the valve except when the cylinder is in use.
 - Use only the correct gas shielding equipment designed for your specific type of cutting, and maintain it properly.
 - Protect gas cylinders from heat, physical damage, slag, flames, sparks, and arcs.
 - Always follow proper procedures when moving cylinders.
- Do not install the machine in an environment with explosive gas to avoid an explosion.

1.7 Additional Safety Information

- Use only the supplied power cord for this plasma cutter or an identical replacement cord. Do not install a thinner or longer cord on this plasma cutter.
- Maintain labels and nameplates on the plasma cutter. These carry important information.
- Ensure the ground clamp is securely connected to the workpiece during cutting.
- Pressing the gun switch when cutting or cutting.
- When disposing of the cutting machine, please note the following:
- Burning electrolytic capacitors on the main circuit or PCB board may cause explosions. Burning plastic components such as the front panel may produce toxic gases. Dispose of it as industrial waste.

1.8 Symbol Explanation

WARNING



Matters to be noticed in operation



Objects to be specially described and pointed out



It is prohibited to dispose the electrical waste together with other common wastes. Please protect the environment.

2. PRODUCT OVERVIEW

The Digital Plasma Cutter: Advanced, Portable, Versatile.

The plasma cutter is a fully-featured digital plasma cutting system that combines high performance with advanced technology in an ultra-portable design. Built to handle a wide range of applications, it is equally effective for manual hand-held cutting and automated robotic integration. This system cleanly cuts all conductive metals, including mild steel, stainless steel, and aluminum. It offers robust cutting capacity with a maximum severance thickness of 3/4" (20 mm), a quality cut thickness of 1/2" (10 mm), and a piercing capability of up to 1/3" (8 mm). Designed with a forward-thinking approach and incorporating proven, advanced technologies, the plasma cutter represents a smart investment, delivering professional results and protecting your long-term value.

2.1 Functions and characteristics:

The Plasma Cutter: Digitally Controlled, Professionally Engineered.

Advanced Digital Control

The plasma cutter features internationally advanced MCU-based intelligent digital control technology, with all major functions managed through integrated software. This digital design delivers significantly improved performance and functionality over traditional plasma cutting systems.

High-Efficiency Inverter Technology

Utilizing PWM technology and high-power IGBT components, the system converts rectified DC voltage from 50/60 Hz AC input into a 30–100 kHz high-frequency AC

signal, which is then transformed and rectified into high-power DC output for cutting. This switching power supply design greatly reduces the machine’s size and weight, increases conversion efficiency, and operates above the audible range to minimize noise.

Consistent, Stable Performance

Unlike analog or hybrid analog- digital systems whose performance depends on individual component tolerances—leading to variation between units and sensitivity to environmental factors—the machine’s fully digital control is insensitive to component parameter drift. This ensures consistent cutting behavior, unit- to- unit uniformity, and reliable operation across temperature and humidity conditions.

Powerful Cutting Capability

The machine operates economically using standard compressed air as the plasma gas source, achieving cutting speeds up to 1.8 times faster than oxy- fuel cutting. It easily cuts stainless steel, copper, cast iron, aluminum, and other conductive metals. With reliable HF arc ignition, post- flow gas control, and straightforward operation, it delivers smooth cuts that often require no further finishing.

2.2 TECHNICAL PARAMETERS

TECHNICAL PARAMETERS	RBC6000DL		
		RBC6000L	RBC4500L
Rated input power supply(V)	Single-phase AC100V~120V 50/60Hz	Single-phase AC200V~240V 50/60Hz	Single-phase AC200V~240V 50/60Hz
Rated input capacity (kVA)	4.5	5.7	5.2
Power factor	0.7		
Rated output (A/V)	35/94	60/106	45/98
Output current range (A)	15~35	15~60	15~45
Rated duty cycle(%)	100	35	35
No-load voltage (V)	310		
Arc ignition mode	HF Non-Contact		
Size	12*4.7*8.46in/305*120*218mm		

Weight		8.8lb/4kg		
Post-flow time (s)		5		
Overall efficiency(%)		85		
Gas pressure range		30~50PSI/0.21 ~0.35Mpa	30~70PSI/0.21~0.49Mpa	
Protection grade		IP21S		
Enclosure ingress protection		F		
Cooling mode		Air Cooling		
Cutting Thickness	maximum cut	1/2"(12mm)	3/4"(20mm)	5/8"(16mm)
	ideal clean cut	5/16"(8mm)	5/8"(16mm)	1/2"(12mm)

2.3 Package

	Package Contents		
	a	Plasma Cutter*1	
	b	AG60 Torch*1	
	b1	Integrated Port (for power, gas)	
	b2	Switch Connector	
	b3	Pilot Arc Cable	
	c	Earth Clamp*1	
	Replacement Parts	1	Holder
		2	Shield Cup
3		Nozzle	
4		Electrode	
Part No	1	RBAG6001	
	2	RBAG6002	
	3	RBAG6003	
	4	RBAG6004	

For optimal performance, the use of genuine original accessories is highly recommended.

3. Panel Instruction

This plasma cutter features a streamlined, intuitive interface. Operation is straightforward: simply adjust the amperage with the dial. Its simplicity makes it ideal for beginners, and setting the current to the maximum is recommended for most cutting applications.

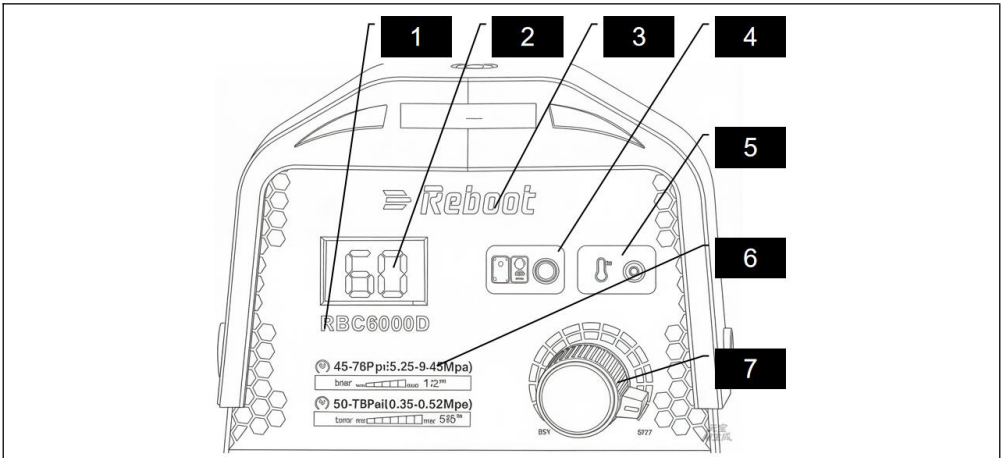

1	Model label	
2	Digital display	digital tube displays current value which is set currently; It displays E02 when machine is under overheat protection and stops working until E02 disappears;
3	REBOOT logo label	
4	Power light	When the equipment power is turned on and the machine is operating normally, the current indicator lamp will light up.
5	Fault Indicator	When the machine stops operating due to a fault, the Fault Indicator lights up.

6	Air Pressure Parameters label	
7	Current knob	Welding current can be adjusted from low to high by rotating the knob clockwise.

4. INSTALLATION AND CONNECTION

WARNING



BEWARE OF ELECTRIC SHOCK!



Check and follow the instructions listed in the "Safety" section of this manual.

WARNING



DO NOT set up without SWITCH OFF!

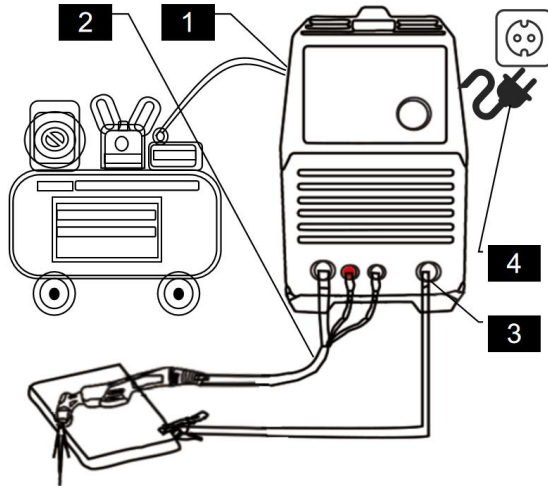

1. Connection of air compressor

The plasma cutter requires compressed air to be attached to the unit. Use a hose clamp to tighten the gas hose to avoid air leakage.

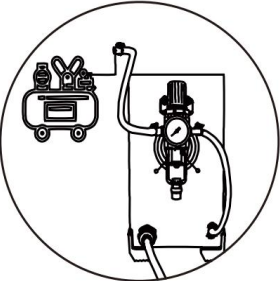
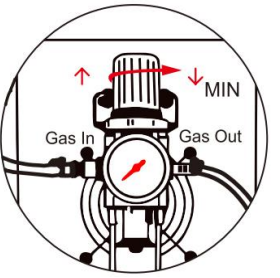
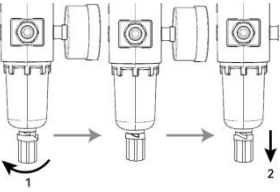
<p>Install the regulator with arrows for Inlet/Outlet. Incorrect connection blocks flow. Input pressure: 30–100 Psi. A compressor $\geq 750\text{W}$ and a flow rate within the range of 6.4 to 7.1 CFM. is recommended.</p> <p>The included regulator is pre-set to 30–70 Psi. The air filter captures water/oil vapor; drain condensate via the bottom valve.</p>	
<p>Steps for reducer setting are as follows:</p> <ol style="list-style-type: none"> 1. lift the pressure control knob upward. adjust the gas pressure to the desired value by rotating the knob (rotate to “+” direction to increase gas pressure; rotate to “-” direction to reduce gas pressure); 2. press down the pressure control knob to get the knob locked. 	
<p>Release water and oil vapor or gas</p> <p>WARINING: DO NOT set up without SWITCH OFF !</p> <ol style="list-style-type: none"> 1. Turn the knob to the left to open the drain knob. 2. Pull the drain knob down to Release water and oil vapor or gas. <p>NOTICE:</p> <p>The drain knob needs to be turned off before the machine can be used properly.</p>	

2.Installation of the cutting torch

Check the torch for proper assembly. Install proper torch parts for the desired application.

1. Connect the Cutting gun to “-” Negative polarity
2. Connect the aviation plug to switched torch connector on the front panel.
3. Connect the Pilot Arc Cable to Pilot Arc Terminal.

NOTICE:

The Cutting gun connector **MUST** be tightly connected to the socket to avoid power

short circuit. Slide the barrel shroud back until it clicks into place, covering the connection.

1. Connect the Electrode into the Torch Head.
2. Connect the Nozzle into the Torch Head.
3. Connect the Shield Cup into the Torch Head.
4. Connect the Wire Spacer Guide onto Shield Cup.

NOTICE:

Ensure all components are securely fastened. Loose installation may result in arc ignition failure.

Installation of the Holder: The open end contact the workpiece, with the opening oriented opposite to the cutting direction.

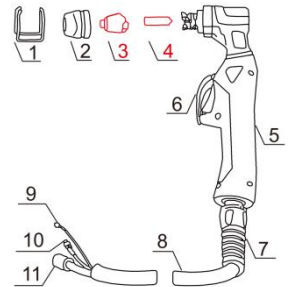

3. Connection of earth cable

Insert the quick plug on the earth cable into the output terminal “+” on the front panel of the machine, and tighten it clockwise.

NOTICE:

The ground clamp connector **MUST** be tightly connected to the socket to avoid power short circuit.

Ensure the ground clamp is connected on clean, bare metal (not rusty or painted).



4. Connection of input power

RBC6000DL operates in 110V/220V power supply. RBC4500L/RBC6000L operates in 220V power supply. Plug the Power Cord into a properly grounded. Set Cutting torch down on nonconductive, nonflammable surface away from any grounded objects. And then then turn the Power Switch ON. The fan should start. The Digital screen should turn on.

NOTICE:

Adjust the Voltage Switch to match the outlet voltage:

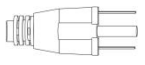
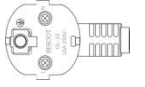
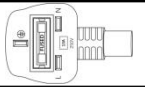
RBC6000DL-America Plug

<p>For 220VAC, attach the provided adapter to the Power Cord.</p>	
<p>For 110VAC, do not use the adapter. Plug the Power Cord into a properly grounded and rated receptacle matching the plug and selected voltage. Need to be connected to circuits with 50A and above circuit breakers.</p>	
<p>RBC4500L/RBC6000L-European Plug</p>	
<p>When operating at maximum current, a circuit breaker with an insufficient current rating may trip. Please confirm that your circuit breaker is rated for 25A or higher.</p>	
<p>RBC4500L/RBC6000L-British Plug</p>	
<p>For a 13A fused plug: To prevent the fuse from blowing, ensure the cutting current does not exceed 23A.</p>	
<p>For optimal cutting performance and to utilize the machine's full capacity, the power input must be upgraded. This work must be performed by a qualified electrician. The standard 13A plug should be replaced with either a dedicated 16A industrial plug and socket, or the unit should be hardwired directly to the supply. Furthermore, the circuit must be protected by a dedicated breaker with a rating greater than 25A.</p>	

WARNING

DO NOT power on until the screen turns off and the fan stops working.

5. Operation

WARNING



BEWARE OF ELECTRIC SHOCK!



NOTICE: To prevent serious injury from fire or electric shock:

1. DO NOT touch anything, especially not the ground clamp, with the gun or cutting wire or an arc will be ignited.

2. DO NOT touch plasma cutter Components while it is plugged in.

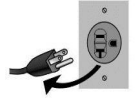

5.1 Pilot Cutting

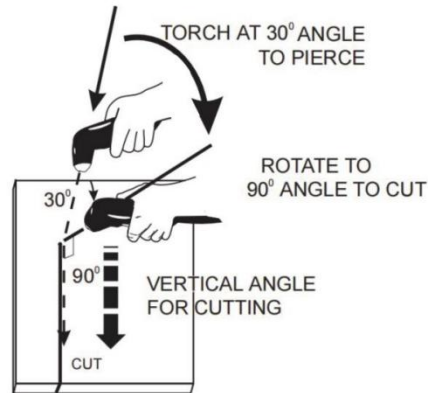
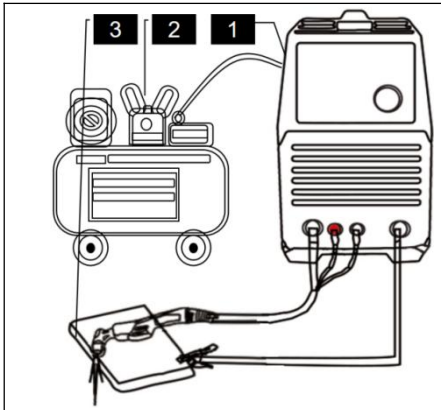

1. Confirm that plasma cutter has been installed and operated correctly.
2. Clamp the Ground clamp onto the workpiece, The Ground clamp must be securely connected to the workpiece.
3. Set the output current control knob at maximum position for higher cutting speed and less dross formation. Reduce the current, if desired to reduce the cut width, heat affected zone or travel speed as required.

1. When ready to cut, place the torch near the work, make certain all safety precautions have been taken and pull the trigger. The pilot arc will start.
 2. Pierce the work piece by slowly lowering the torch onto the metal at a 30° angle away from the operator. This will blow the dross away from the torch nozzle. Slowly rotate the torch to vertical position as the arc becomes deeper.
- NOTE:** Graphics shown are for understanding torch angles for best results – the distances from the workpiece are exaggerated. In actual operation, the nozzle should be held just above the work piece surface.

5.2 Optimized Operation Guidelines

Torch Control & Nozzle Use

- For improved stability, you may lightly drag the nozzle along the workpiece surface. Note: This will reduce nozzle life.
- Alternatively, a non-conductive guide or standoff can be used to maintain a consistent distance for a cleaner cut.

Postflow & Trigger Operation

- Releasing the trigger stops the arc. Postflow gas continues for 5 seconds to cool the torch.
- If the trigger is pulled again within this period, the arc will re-strike immediately.

Cutting Quality Adjustments

- If dross is difficult to remove, reduce the cutting speed. High-speed dross is typically harder to clean than low-speed dross.
- When viewed in the direction of travel, the right side of the kerf is generally squarer than the left side.

Maintenance

- Regularly clean spatter and scale from the nozzle to maintain cut quality and extend consumable life.

5.3 Parts in place

If the accessories of cutting torch need to be replaced, please log in to the official website:

WWW.REBOOTEC.COM

Torch Consumables Inspection & Maintenance

1. Assembly Check

- Verify that all torch consumables are correctly assembled and seated. Improper assembly will prevent the machine from starting.
- Ensure the shield cup is hand-tight only. Do not use tools or over-tighten.

2. Nozzle Inspection & Cleaning

- Inspect the nozzle interior. If debris is present, lightly rotate the electrode inside

the nozzle bottom to remove any oxide buildup. (See “Routine Maintenance” for details.)

3. Electrode Inspection

- Check the electrode tip. A cratered appearance indicates wear; replace both the electrode and nozzle as a set.
- Maximum allowable wear depth is approx. 0.062” (~1.6 mm).
- A green, erratic arc confirms electrode failure. Replace immediately.

4. Nozzle Replacement

- Replace the nozzle if the orifice is eroded, enlarged, or oval-shaped.

5.4 Pilot Arc Operation & Guidelines

1. Function & Design

The CUT system produces a smooth, continuous pilot arc. This arc serves solely to transfer the main cutting arc to the workpiece and is not intended for repeated, non-cutting ignition cycles.

2. Recommended Practice

- Avoid rapid, successive pilot-arc starts, as this shortens consumable life.
- The pilot arc is optimized for reliable transfer to the workpiece, not for frequent ignition without cutting.

3. Normal Operation & Indicators

- A slight mechanical impulse in the torch handle is normal upon pilot-arc initiation. This is part of the arc-starting mechanism.
- This impulse can also serve as a useful diagnostic indicator when troubleshooting a "no-start" condition.

4. Troubleshooting Note

If the pilot arc sputters or starts intermittently, common causes include:

- Worn consumables (electrode/nozzle).
- Excessively high air pressure.

NOTICE:

During arc ignition, a blue arc light may be visible through the front-panel grille. This is a normal characteristic of the HF ignitor.

5.5 Notes for cutting operation

WARNING



BEWARE OF ELECTRIC SHOCK!



	<p>Avoid unnecessary arc ignition in air, as this will shorten the torch electrode and nozzle life. If the torch trigger is held for more than 3 seconds without contacting the workpiece, the arc will automatically shut off.</p>
	<p>For best results, start the cut from the edge of the workpiece unless piercing is required.</p>
	<p>Proper cuts are indicated by spatter exiting from the bottom of the workpiece. If spatter is observed coming from the top, it indicates incomplete penetration. This is typically caused by excessive travel speed or insufficient cutting current.</p>
	<p>Maintain light contact between the nozzle and workpiece, or a small standoff distance. Pressing the torch firmly against the workpiece can cause the nozzle to stick and result in an uneven cut.</p>
	<p>When cutting round workpieces or when precise cuts are required, the use of a fixture, template, or other positioning aids is recommended.</p>
	<p>The preferred technique is to drag the cutting torch along the direction of travel.</p>
	<p>Torch Operation & Safety</p> <ol style="list-style-type: none"> 1. Torch Position & Arc Tracking Hold the torch so the nozzle is perpendicular to the workpiece surface. Visually confirm the arc is centered on and tracking your cut line. 2. Cable Management Do not sharply bend, step on, or pinch the torch cable—especially

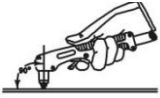

in confined spaces.

Keep the cable clear of sharp edges, hot surfaces, and moving parts.

3. Gas Flow Warning

Restricting the cable can block gas flow, leading to insufficient cooling. This may overheat and damage the torch.

Nozzle & Torch Head Cleaning

1. Standard Maintenance Instructions

To maintain optimal thermal performance, promptly remove spatter buildup from the nozzle, as it can insulate heat and reduce cooling efficiency. After each use, also clean dust and spatter from the torch head to ensure consistent heat dissipation.

2. Concise Daily Checklist

After use: Clean all spatter and dust from the torch head and nozzle.

Why: Debris acts as an insulator, reducing cooling and risking torch damage.

3. Detailed Procedure

Regular spatter removal is critical for torch longevity. Spatter on the nozzle creates a thermal barrier that inhibits cooling, while accumulation on the torch head restricts airflow. Clean both areas thoroughly at the end of each workday.



The workpiece is not cut fully. This may be caused by:

1. The cutting current is too low.
2. The cutting speed is too high.
3. The electrode and nozzle of the torch are burned.
4. The workpiece is too thick.

Molten slag drops from the bottom of workpiece. This may be caused by:

1. The cutting speed is too low.
2. The electrode and nozzle of the torch are burned.
3. The cutting current is too high.

6.Cutting Guide

For 95% of operational issues: follow the steps below.Beginners: start with thin sheets and practice more.

Before cutting

Position	Torch perpendicular, nozzle center at edge.
Start	Ignite arc, move slowly after vertical arc stabilizes.
If stuck	Slow down, restart cut.
Beginner tip	Start on 3mm plate.





Cutting Operation Specifications

Operation Element	Specification
Torch Posture	Maintain a perpendicular torch throughout cutting
Spark Control	Keep spark spray angle within 30° of vertical
Parameter Adjustment	Reduce speed if the angle exceeds 30°
Exception Handling	If spark spray back occurs, stop and restart from a new point.



End-Cutting Procedure		
Step	Action	Note
1. Pause & Observe	Stop torch at edge, wait for vertical arc and red-hot workpiece edge	Ensures complete penetration
2. Complete Cut	Slowly move torch forward to finish	Prevents incomplete cuts
3. Spark Control	If spark splashback occurs, stop immediately	Avoids torch damage
4. Beginner Tip	Prepare spare parts and practice more	Splashback is common for newcomers

	
--	--

7. MAINTENANCE

WARNING



BEWARE OF ELECTRIC SHOCK!



NOTICE:

The power of the switching box and the cutting machine should be shut down before daily checking (except appearance checking without contacting the conductive body) to avoid personal injury accidents such as electric shock and burns.

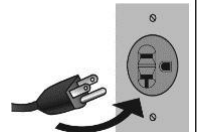

Tips:

1. Daily checking is very important in keeping the high performance and safe operation of this cutting machine.
2. Do daily checking according to the table below, and clean or replace components when necessary.
3. In order to ensure the high performance of the machine, please choose components provided or recommended by dealer when replacing components.

Daily checking of the cutting machine		
Items	Checking requirements	Remarks
Front panel	Whether any of the components are damaged or loosely connected; Whether the output quick sockets are tightened; Whether the abnormality indicator illuminates.	If unqualified, check the interior of the machine, and tighten or replace the components.
Back panel	Whether the input power cable and buckle are in good condition; Whether the air intake is unobstructed.	
Cover	Whether the bolts are loosely connected.	If unqualified, tighten or replace the components.
Side plates	Whether the side plate is loosely fixed.	
Chassis	Whether the screws are loosely connected.	
Routine	Whether the machine enclosure has color fading or overheating problems; Whether the fan sounds normal when the machine is running; Whether there is abnormal smell, abnormal vibration or noise when the machine is running.	If abnormal, check the interior of the machine.

Daily checking of the cables		
Items	Checking requirements	Remarks
Earth cable	Whether the grounding wires (including workpiece GND wire and cutting machine GND wire) break off.	If unqualified, tighten or replace the components.

Cutting cable	Whether the insulating layer of the cable is worn, or the conductive part of the cable is exposed; Whether the cable is drawn by an external force; Whether the cable connected to the workpiece is well connected.	Use appropriate methods according to the work site situation to ensure safety and normal cutting.
---------------	---	---

8. TROUBLESHOOTING

WARNING



BEWARE OF ELECTRIC SHOCK!



The abnormality indicator on the front panel would illuminate in case of any failures inside the cutting machine

Malfunction phenomena	Cause and solution
Turn on the machine, the LED screen illuminates, the control PCB keys do not function, and there is no response when pushing the torch trigger.	The cutting machine crashes: Shut down the machine, and restart it.
Turn on the machine, the LED screen illuminates, the control PCB keys work normally, but there is no response when pushing the torch trigger.	1) The LED3 on the main board is on: The control PCB is damaged. 2) The LED3 on the main board is off: Check the torch trigger and torch trigger wire.
Turn on the machine, the LED screen illuminates, and the fan works. When pushing the torch trigger, the solenoid valve functions, but there is no HF	The arc ignition part fails: 1) The interelectrode distance of the discharge nozzle is too long. 2) There is leakage of the HF capacitor 222/15KV.

discharge rustling.	3) The mosfet or the optocoupler on the HF board is damaged. 4) The input voltage is too low.
Arc can not be ignited.	1. The air pressure is overly high or overly low. 2. Replace the electrode or nozzle

Fault code table

Code	Code meaning
E01	Over current Protection Protection action is hardware-controlled by the power circuit in the control module; the software passively displays the status. Upon detection of the E01 signal, the software will disable the output.
E02	Overheat Protection: The temperature is monitored at the IGBT near the air outlet. When the temperature reaches approximately 120°C, the output will be disabled. It will automatically resume once the temperature drops to about 65°C.
E03	Temperature Sensor Disconnected Alert: The alert will automatically clear once a sensor signal is detected.
E04	Abnormal Temperature Rise Alert.The alert will be automatically canceled once the system returns to normal operating conditions.
E05	Alert: Temperature is rising too fast.Please check the fan operation.The system will automatically return to normal once the fan is functioning correctly.
E06	Air Pressure Failure Protection: Stop operation and check the compressed air supply immediately. The plasma cutter requires compressed air to operate — ensure it is properly connected and the pressure is sufficient. This error code is displayed intermittently. E06 under-pressure protection is automatically disabled when the digital pressure gauge is set to temperature display mode.

9. Warranty Registration

To ensure optimal performance and consistency, we recommend purchasing genuine spare parts exclusively from the official REBOOT website. You may also register your product there to activate your warranty.

Official Website:

<https://www.rebootec.com>

Warranty Registration

REBOOTEK Warranty Registration

Accurately fill in the following information for warranty registration

* First Name

* Last Name

* Email

* Phone Number

Serial Number of Machine

* Order Number